

PICO ULTRA PLUS +

Wall-mounted spot ventilation unit with heat recovery and timer programming

- cod. ACD100069 - cod. ACD100070 - cod. ACD100071



DESCRIPTION

PICO ULTRA PLUS+ is an innovative system designed to improve thermal comfort and air quality in residential environments.

PICO ULTRA PLUS+ is able to operate in both directions, which means it can be used to ventilate and recover the heat of the environment according to requirements. This allows a comfortable microclimate to be maintained in all seasons.

Energy Saving: This system is designed to maximize energy saving, thus reducing the costs associated with heating and cooling of the interior spaces. Thanks to its efficient operation, it contributes to reducing environmental impact.

Optimized Ventilation: PICO ULTRA PLUS + ensures effective ventilation and adequate air exchange inside the rooms, improving air quality and contributing to the well-being of the occupants.

High Efficiency: The vacuum extractor integrated in PICO ULTRA PLUS offers a high performance, with the extraction capacity that can reach up to 90%. This is made possible by the presence of a ceramic honeycomb heat exchanger, which maximizes thermal efficiency.

Easy Installation and Maintenance: PICO ULTRA PLUS is designed for easy installation and requires simple maintenance. This simplifies the management of the system, reducing maintenance costs over time.

The connection to the electrical network to the device is made directly from the prearranged clamp integrated in the wall dashboard, to ensure quick assembly and maintenance of the PICO.

The ventilation unit front panel is made from white ABS.

The unit is equipped with an automatic closing damper and remote control, supplied as standard.

The wall through pipe is 50 cm long and contains the ceramic heat exchanger and grade G2 incorporated filters.

An external element with rain guard completes the installation.

All the PICO functions can also be controlled via the APP through a remote or local wifi connection directly from your smartphone or tablet, simply and intuitively.

Simply download the Tecnosystemi application and pair your device.

FUNCTIONAL FEATURES

- For wall installation, minimum installation wall thickness: 270 mm
- Front wall thickness 35 mm
- Available with flow rates from 30 to 60 m³/h
- Energy Class A
- Wi-fi control mode 2.4 GHz via APP: local or remote connection
- Integration Voice assistants and Google Home
- Automatic closing damper
- Comfort – CO₂ Threshold – Heat Recovery – Extraction – Supply – Humidity Threshold – Natural Recirculation – Free Cooling – Free Heating – Night Mode – Hourly and Weekly Programming
- MASTER function / SLAVE: Possibility to connect in cascade via WIFI up to 4 slaves
- Slaves configurable in synchronous or asynchronous mode.
- Humidity threshold can be set to 3 different values: 40 - 50 - 60%
- Heat exchanger made of high-efficiency ceramic
- Rating IPX4 (external)
- Fan with low energy consumption, suitable for continuous operation
- Equipped with remote control
- RGB LED on front for mode display
- 4 speeds — min, medium, max and night mode — preset from the remote control and adjustable via the app
- Mounting Hole Sections Ø103 - Ø128 - Ø153
- CO₂ indicators, indoor and outdoor humidity and air quality index in APP
- Weekly programming of hours in 4 bands with mode and operating speed setting via APP.

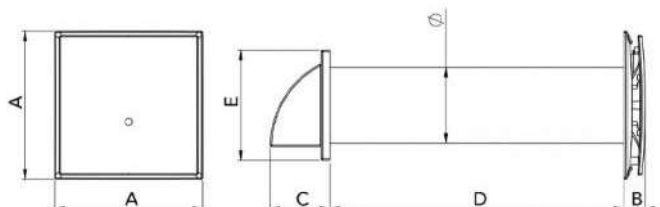

DIMENSIONS

CODE	MODEL	A [mm]	B [mm]	C [mm]	D [mm]	E [mm]	Ø [mm]	WEIGHT [kg]
ACD100069	PICO ULTRA PLUS+ 30	250	35	86	500	154	103	2,0
ACD100070	PICO ULTRA PLUS+ 45	250	35	101	500	186	128	2,2
ACD100071	PICO ULTRA PLUS+ 60	250	35	101	500	186	153	3,2

REFERENCES

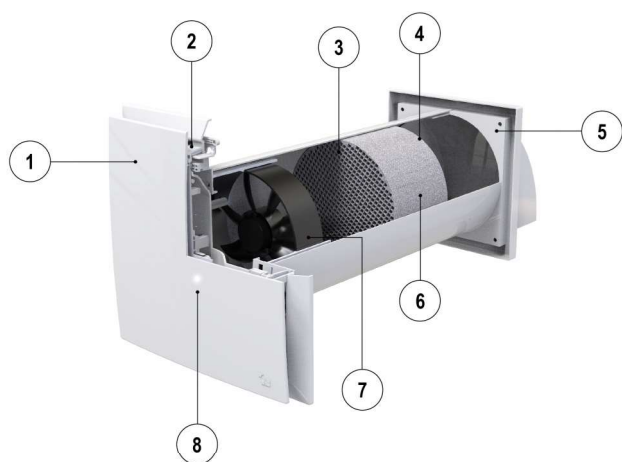

- [1] Aesthetic front panel
- [2] Mechanical damper
- [3] Filter 1
- [4] Filter 2
- [5] External grille
- [6] Exchanger pack
- [7] Bidirectional fan
- [8] RGB mode LEDs

TECHNICAL DATA

	DATA
Power supply	90-240 Vac +/- 10%, 50/60 Hz
Insulation	II
Protection rating	IPX4
Type of installation	Fixed
Control	Remote control / App / Time programming
Communications	WiFi 2.4 GHz
Messages	Multi-colour RGB LED
Motors	Brushless DC PWM controlled
Exchanger type	High-efficiency ceramics
Body material	ABS
Operating temperature	-10°C / +40°C C13(-10T40)
Relative operating humidity at room temperature of 25° C	85 rH%
Storage temperature	min -20°C - max 70°C
Service class	CONTINUOUS
Minimum wall thickness	270mm

PICO ULTRA PLUS+ 30

TECHNICAL DATA	Standby	NIGHT		minimum speed		Average speed		Maximum speed	
		Extraction	Immission	Extraction	Immission	Extraction	Immission	Extraction	Immission
Mode	/								
Consumption [W]	<1	1.5		2		3		4	
Air flow rate [m³/h]	/	6		10		20		30	
Sound pressure [dB(A)] @2m	/	18	19	22	23	26	27	29	32
ENERGY RATING SEC	A								
Type	Bidirectional UVR								
Type of recovery system	Regenerative type HRC3b								
Filtration class	G2								
Filter signal	Red flashing light indication on front fixture								
Internet address with pre-assembly and disassembly instructions	www.tecnosystemi.com								

PICO ULTRA PLUS+ 45

TECHNICAL DATA	Standby	NIGHT		minimum speed		Average speed		Maximum speed	
		Extraction	Immission	Extraction	Immission	Extraction	Immission	Extraction	Immission
Mode	/								
Consumption [W]	<1	1.5		2		3		4.5	
Air flow rate [m³/h]	/	8		20		30		45	
Sound pressure [dB(A)] @2m	/	20	22	24	27	28	30	35	37
ENERGY RATING SEC	A								
Type	Bidirectional UVR								
Type of recovery system	Regenerative type HRC3b								
Filtration class	G2								
Filter signal	Red flashing light indication on front fixture								
Internet address with pre-assembly and disassembly instructions	www.tecnosystemi.com								

PICO ULTRA PLUS+ 60

TECHNICAL DATA	Standby	NIGHT		minimum speed		Average speed		Maximum speed	
		Extraction	Immission	Extraction	Immission	Extraction	Immission	Extraction	Immission
Mode	/								
Consumption [W]	<1	1.7		3		4.5		7	
Air flow rate [m³/h]	/	11		30		40		60	
Sound pressure [dB(A)] @2m	/	24	28	30	32	35	38	40	41
ENERGY RATING SEC	A								
Type	Bidirectional UVR								
Type of recovery system	Regenerative type HRC3b								
Filtration class	G2								
Filter signal	Red flashing light indication on front fixture								
Internet address with pre-assembly and disassembly instructions	www.tecnosystemi.com								















NOTES:

Data according to Regulation (EU) 1253/2014 and Regulation (EU) 1254/2014.
N/A = not applicable to the type of product

EASILY CONTROLLED WITH REMOTE CONTROL OR WITH APP TECNOSYSTEMI



Functionality

FUNCTION	PICO PRO	PICO ULTRA PLUS+		LED
HEAT RECOVERY		✓		
EXTRACTION		✓		
IMMISSION		✓		
HEAT RECOVERY HUMIDITY THRESHOLD		✓		
HUMIDITY EXTRACTION THRESHOLD		✓		
AIR EXCHANGE		✓		/
FREE COOLING	/	✓		
FREE HEATING	/	✓		
CO2 HEAT RECOVERY THRESHOLD	/	✓		
CO2 EXTRACTION THRESHOLD	/	✓		
CO2 HUMIDITY HEAT RECOVERY THRESHOLD	/	✓		
CO2 HUMIDITY EXTRACTION THRESHOLD	/	✓		
NIGHT MODE		✓		/
MASTER/SLAVE CASCADE MODE		✓	/	/
FILTER MAINTENANCE INDICATION		✓	/	/
DEACTIVATING / ACTIVATING WIFI		✓	/	/
LED SWITCH-OFF		✓	/	/
INTEGRATION WITH VOICE ASSISTANTS (Google HOME - AMAZON ALEXA)		✓	/	/
DAMPER		✓	/	/
SCHEDULE	/	✓	/	/
REMOTE CONTROL		✓	/	/

ITEMS

CODE	DESCRIPTION
ACD100069	
ACD100070	
ACD100071	

All rights relating to this publication are the exclusive property of Tecnosystemi SpA. Tecnosystemi SpA reserves the right to make changes at any time and without notice, for technical or commercial needs.